



# Cup Systems



Now collect with every cup!

**SATA® LoyaltyProgram**  
coins & more

Further information: [www.sata.com/loyalty](http://www.sata.com/loyalty)

# SATA® RPS® Multi-Purpose Cup System



## SATA RPS

Suitable for all paint materials! Please observe the recommendations of the paint manufacturers to choose the correct sieves (flat sieve 125 µm or plug-in sieve 200 µm).



### SATA RPS 0.3 I minijet for SATAMinijet 3000 B

#### Packing unit 60 pieces

1010553	SATA RPS 0.3 I minijet, 125 µm flat sieve		
1010561	SATA RPS 0.3 I minijet, 200 µm plug-in sieve		

### SATA RPS 0.3 I Standard

Packing unit 40 pieces	Packing unit 100 pieces		
1010389	1010420	SATA RPS 0.3 I standard, 125 µm flat sieve	<b>Packing unit 40 pieces:</b> <b>Packing unit 100 pieces:</b>
1010397	1010404	SATA RPS 0.3 I standard, 200 µm plug-in sieve	<b>Packing unit 40 pieces:</b> <b>Packing unit 100 pieces:</b>

### SATA RPS 0.6 I

#### Packing unit 60 pieces

1010438	SATA RPS 0.6 I 125 µm flat sieve		
1010488	SATA RPS 0.6 I 200 µm plug-in sieve		

### SATA RPS 0.9 I

#### Packing unit 40 pieces

1011973	SATA RPS 0.9 I, 125 µm flat sieve		
1011981	SATA RPS 0.9 I, 200 µm plug-in sieve		

### SATA RPS 0.6 I UV

#### Packing unit 60 pieces

1010496	SATA RPS UV 0.6 I 125 µm flat sieve		
1010503	SATA RPS UV 0.6 I 200 µm plug-in sieve		

All prices are recommended list prices. Errors, technical modifications and printing errors reserved.

# Spare Parts SATA® RPS®

Art. No./Descr.
1013226 Spare lid for SATA RPS 0.6 l / 0.9 l (packing unit 80 pieces)
131979 Spare flat sieve 125µm, pastel blue (packing unit 100 pieces) for SATA RPS 0.6l / 0.9l
131987 Spare plug-in sieve 200 µm, pastel green (packing unit 100 pieces) for SATA RPS 0.3 l / 0.6 l / 0.9 l
160606 Spare flat sieve 125 µm, pastel blue (packing unit 60 pieces) for SATA RPS 0.3 l
1013218 Spare lid for SATA RPS 0.3 l Standard (packing unit 60 pieces)
1013234 Spare lid for SATA RPS 0.3 l minijet (packing unit 108 pieces)

## SATA RPS 0.3 l Standard

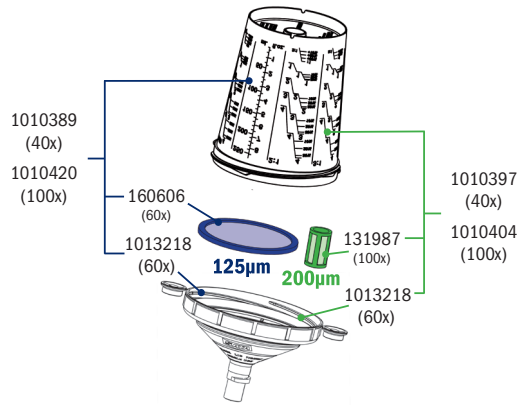

## SATA RPS 0.3 l minijet (for SATAMinijet 3000 B)

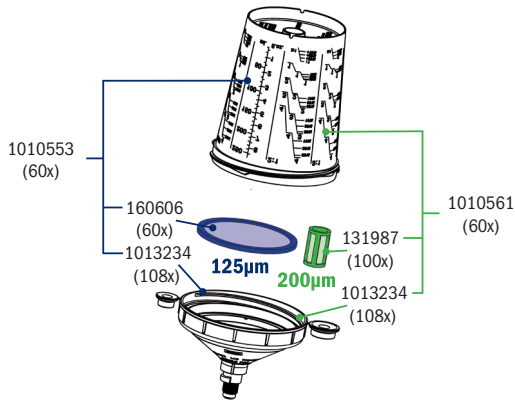

## SATA RPS 0.6 l

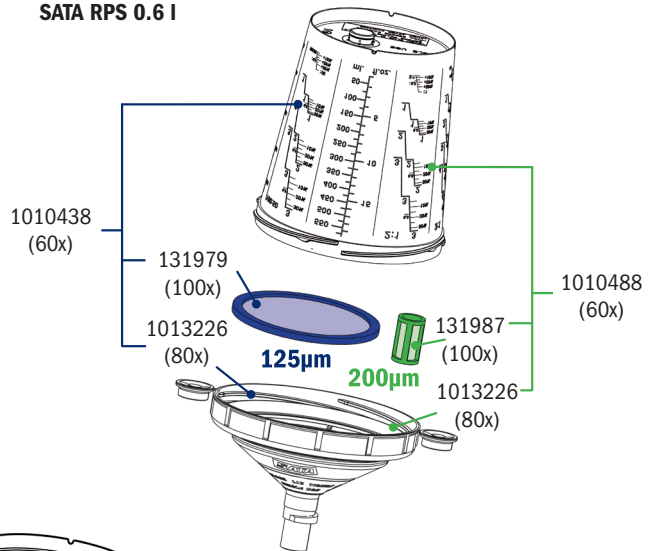

## SATA RPS 0.9 l

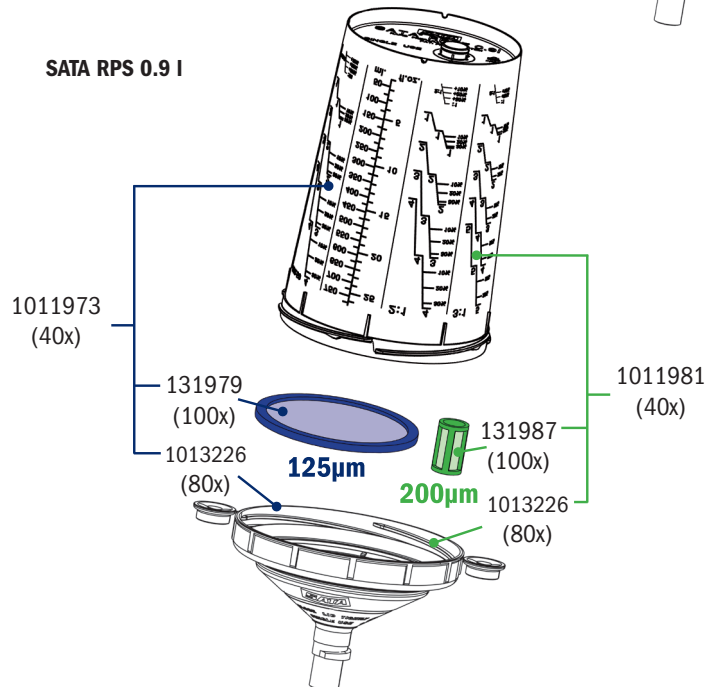

All prices are recommended list prices. Errors, technical modifications and printing errors reserved.

# SATA® RPS® Accessories





## SATA RPS dispenser System

### Technical Data







SATA RPS wall dispenser	W x H x D: 80 x 100 x 18 cm
SATA RPS extension kit	W x H x D: 40 (120) x 100 x 18 cm
SATA RPS rotawall adapter kit	B: Ø 65 cm; H: 136 cm
SATA RPS rotafloor adapter kit	B: Ø 65 cm H max.: 210 cm; H min.: 123 cm

### Versions











195784	SATA RPS wall dispenser, standard version: 2x cup tubes / 2x lid tubes / 2x sieve tubes and 2x aluminium slats	
195776	SATA RPS extension kit, add-on kit: 1x cup tube / 1x lid tube / 1x sieve tube for flat sieves, with aluminium slat	
196543	SATA RPS rotawall adapter kit: carousel ground spindle and wall holder (top and bottom)	 * Tubes are not included in the scope of delivery.
196550 + 197723 (floor plate)	SATA RPS rotafloor adapter kit: carousel ground spindle, steel pipe	 * Tubes are not included in the scope of delivery.

### Accessories for SATA RPS

144840	SATA RPS depot to store RPS boxes	
127852	Spray bottle 1.0 l	
127860	Pump-spray cleaning bottle, not suitable for thinner	
165399	SATA RPS mix lid, flat lid (packing unit 50 pieces) allows stacking of RPS 0.6 l and 0.9 l cups	

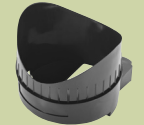
All prices are recommended list prices. Errors, technical modifications and printing errors reserved.

**Accessories for SATA RPS**

213629	Fixing kit for dispenser tubes lid/cup with adhesive pad, adhesive foil, holder for SATA RPS dispenser	
213637	Cup holder for tube for SATA RPS dispenser	
213645	Absorption brush for lid standard for SATA RPS dispenser	
213652	Absorption brush for lid mini for SATA RPS dispenser	
213660	Dispenser tube for lids for SATA RPS dispenser	
213678	Cardboard tube for cups for SATA RPS dispenser	
213686	Tube for plug-in and flat sieves for SATA RPS dispenser	
215483	Fixing rivet (packing unit 4 pieces) for absorption brush for SATA RPS dispenser	
215616	Spare part flat sieve dispenser bottom (1x) for SATA RPS dispenser	
1008285	Support frame for lid dispenser for SATA RPS dispenser	
1008227	Dispenser flap for plug-in sieve for SATA RPS dispenser	
1008219	Dispenser bowl for plug-in sieve for SATA RPS dispenser	
1028605	Bracket for plug-in sieve dispenser tray for SATA RPS dispenser	









All prices are recommended list prices. Errors, technical modifications and printing errors reserved.

# Gravity flow cup for spray guns





Gun type		QCC/ w/o connection thread, suitable for: SATAjet X 5500, SATAjet 5000 B, jet 4000 B, jet 3000 B, jet 2000, jet 1000 B, jet 100 B, jet RP, SATAminijet 4400 B	QCC/ with connection thread, suitable for: SATAjet 2000, jet RP, KLC, LM 2000 B, jet 90	SATAjet B, jet GR, jet NR 95	SATAminijet 3000 B, minijet 1 - 4, jet 20 B
Capacity	Art. No.				
<b>PVC reusable cup</b>					
0,125 l	197541				
0,125 l	125443				
0,3 l	48587				
0,3 l	120675				
0,3 l	128470				
0,6 l	49379				
0,6 l	27243		1004960 		
<b>Multi-Purpose Cup</b>					
0,3 l	1010553				each 60 x 
0,3 l	1010561				each 60 x 
0,3 l	1010389	each 40 x 		 ⊕  125211	
0,3 l	1010397	each 40 x 		 ⊕  125211	
0,3 l	1010420	each 100 x 		 ⊕  125211	
0,3 l	1010404	each 100 x 		 ⊕  125211	
0,6 l	1010438	each 60 x 		 ⊕  125211	 ⊕  135798
0,6 l	1010488	each 60 x 		 ⊕  125211	 ⊕  135798
0,9 l	1011973	each 40 x 		 ⊕  125211	 ⊕  135798
0,9 l	1011981	each 40 x 		 ⊕  125211	 ⊕  135798

All prices are recommended list prices. Errors, technical modifications and printing errors reserved.

# RPS® Adapters for SATA Spray Guns

Gun type	Art. No.	QCC/ w/o connection thread, suitable for: SATAjet X 5500, SATAjet 5000 B, jet 4000 B, jet 3000 B, jet 2000, jet 1000 B, jet 100 B, jet RP, SATAminijet 4400 B	QCC/ with connection thread, suitable for: SATAjet 2000, jet RP, KLC, LM 2000 B, jet 90	SATAjet B, jet GR, jet NR 95	QCC WITH connection thread for: SATAminijet 3000 B, minijet 1 - 4, jet 20 B	
<b>aluminium reusable cup</b>						
0,15 l	198911					
0,15 l	125948					
0,75 l	6601					
0,75 l	137729		1013432 			
1,0 l	46631					
1,0 l	96685		1013440 			
	71555	Plastic lid (packing unit 3 pieces) for 0.75 l and 1.0 l reusable aluminium cup				

# RPS® Adapters for SATA Spray Guns

















Adapters with QCC for SATA spray guns without QCC for a quick change of SATA RPS 0.9 l and 0.6 l and 0.3 l "Standard"		SATA										
		SATAjet B / GR	SATAjet H / SATAjet 1000 H	SATAminijet 2, 3, 4, SATAminijet 3000, SATAjet 20 B	SATAminijet 1000 H	SATAjet 2000 HVLP without QCC	SATAjet RP without QCC	SATA LM 2000 HVLP/RP	SATA KLC HVLP/RP, KLC P	SATAjet 90	SATAjet B NR 92 HVLP, NR 95 HVLP	SATA LM B 92
	125211 (Nr. 1) M 16 x 1.5 female thread	X									X	
	125237 (Nr. 2) M 15 x 1.5 male thread					X	X	X	X	X		
	133595 (Nr. 7) 12 x 1.5 male thread											X
	135798 (Nr. 10) M 10 x 1 male thread			X								
	188318 (Nr. 17) G 1/4 female thread				X							

(No. ...) Adapter Numbers

All prices are recommended list prices. Errors, technical modifications and printing errors reserved.



# RPS® Adapters for NON SATA GUNS

Adapters with QCC for competitor spray guns for a quick change of SATA RPS 0.9 l and 0.6 l and 0.3 l "Standard"	DeVilbiss				IWATA				Walcom		Kremlin	Graco	Dürr	Sharpe	Sagola			Eminent	Asturo	Airgunsa	Dux	
	PHI, GTI, GPP, GRV, GFHV 510, DV 1	SRI	Starting Line HVP Spray Gun	Starting Line Mini Spray Gun	W 400, WR 400, LPH 94, VXL Primer Gun, LPH 400	W 300, LPH 300, LS 400 Supernova, WS 400	W 100, LPH 100	LPH 80	FX GEO, FX HVP	Genesis Carbon	M 21 G	3M PPS	Ecogun 910	Finex FX 300	Platinum, Titanium	475 Mini-Gun	403 G, 433 G, 434 G, 444 G, 450 G, 4100 G	4400 G Extreme, 4500 G Extreme	E13	OM Green	AZ40 HFE	Gravity flow cup spray gun
 125211 (Nr. 1) M 16 x 1.5 female thread					X																	
 125237 (Nr. 2) M 15 x 1.5 male thread									X													
 125252 (Nr. 3) 3/8" male thread	X																					
 125278 (Nr. 4) 1/4" male thread					X													X		X		
 125294 (Nr. 5) M 12 x 1 male thread								X											X			
 126326 (Nr. 6) 3/8" male thread											X											
 133595 (Nr. 7) 12 x 1.5 male thread																X						X
 133827 (Nr. 8) G 3/8" female thread												X	X									
 135111 (Nr. 9) NPSF 3/8" - 18 male thread														X								
 135798 (Nr. 10) M 10 x 1 male thread															X							
 150136 (Nr. 13) M 15 x 1.5 male thread			X																			
 150151 (Nr. 14) M 11 x 1 male thread				X																		
 164608 (Nr. 15) 7/16" - 14 UNC male thread		X																				
 188664 (Nr. 18) M 18 x 1.5 Female thread																	X					
 193276 (Nr. 19) 1/8" male thread							X															
 215079 (Nr. 20) 1/4" male thread										X												

(No. ...) Adapter Numbers

All prices are recommended list prices. Errors, technical modifications and printing errors reserved.

# SATA® Agitator Cup

SATA agitator cup		
9951	SATA agitator-cup for SATAjet B and GR/B-92 (supplementary equipment)	
29926	SATA agitator cup, conversion kit for SATAjet 5000 B, 4000 B, jet 3000 B, jet 2000, jet RP, jet 1000 B, LM 2000 B	

Art. No./Descr.
1503 Countersunk screw M4 x 8 DIN 965, stainless steel, for micrometer und round/flat spray control
1826 Anti-drip device (packing unit 4 pieces)
2188 Spindle
9951 SATA agitator-cup for SATAjet B and GR/B-92 (supplementary equipment)
20461 Plastic air hose for BVD and agitator cup
21055 Agitating vane, cpl.
21063 Driving wing, cpl. with screw
21071 Gasket agitating vane, agitator cup
29926 SATA agitator cup, conversion kit
44735 Countersunk screw M 2.5 x 5, VA
44743 Control knob
44792 Spindle complete for SATAminijet
51078 Regulation valve compl. for cup agitator
53785 Angle screw socket, LCN-1/8-PL-4, f. SATA NAD and BVD
53793 Coupling with G 1/8" (female thread)
54049 Sealing ring (packing unit 4 pieces)
65557 Control knob
123513 Pressure gauge 0-10 bar, 40 mm for regulation valve coloured stereotype plate

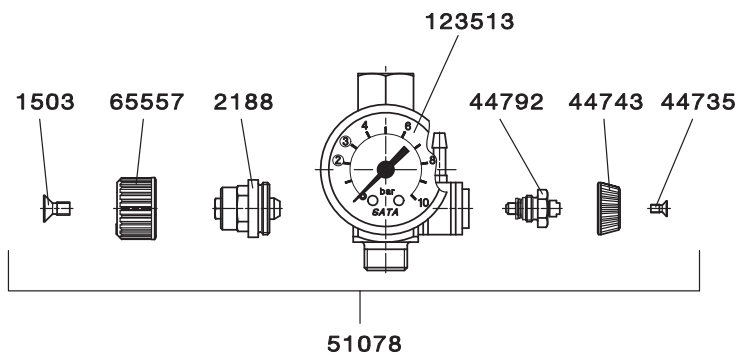
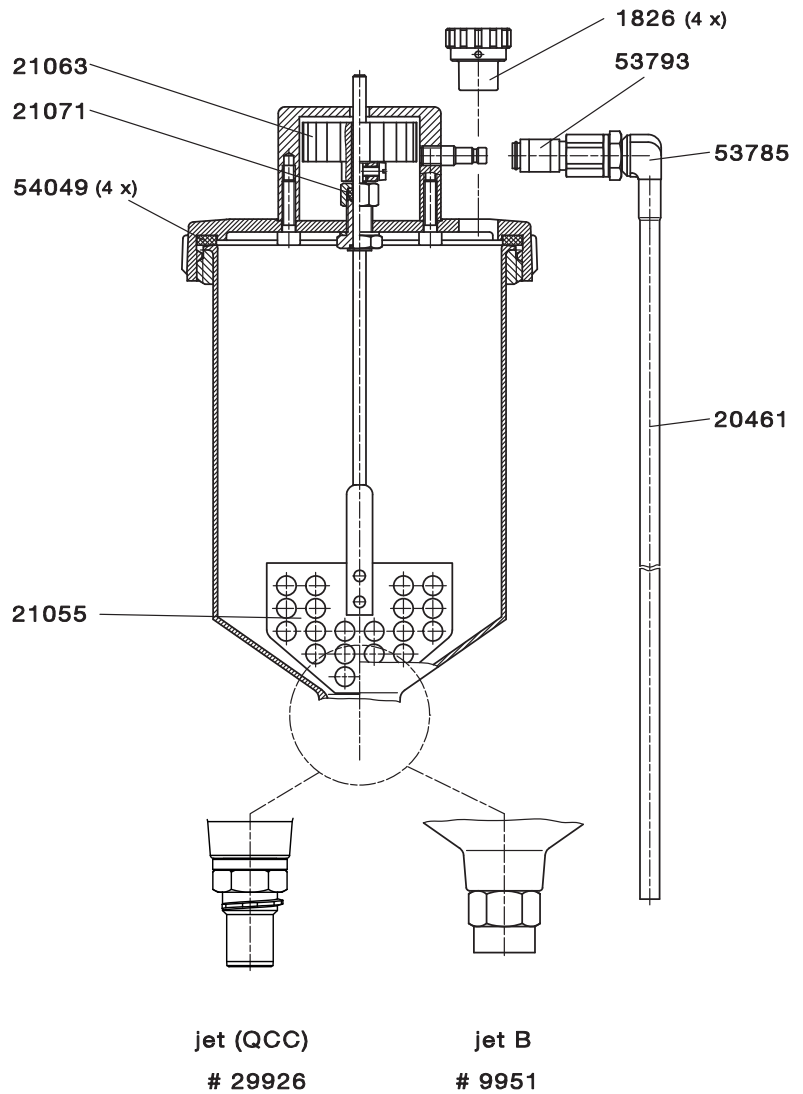

All prices are recommended list prices. Errors, technical modifications and printing errors reserved.

# SATA® BVD™

SATA BVD conversion kit		
25775	SATA BVD conversion kit with QCC without fine thread for SATAjet 5000 B, 4000 B, jet 3000 B, jet 2000, jet 1000 B, jet 100 B, jet RP	
57505	SATA BVD extension-set for SATAjet B and GR/B-92	
73254	Repair kit for control fitting spray master and BVD	

Art. No./Descr.	
8268	Sealing ring
20438	Safety pressure relief valve BVD
20461	Plastic air hose for BVD and agitator cup
21014	Aluminium lid, cpl.
21048	Pressurized cup with lid
25577	Pressurized cup with lid
53777*	Air connection for aluminium lid
54049	Sealing ring (packing unit 4 pieces)
65920	Control fittings, complete, for BVD pressurized cup connection kit (GR and LM)
70664	Anti-drip device (packing unit 10 pieces)
83493	Connection for pressurized cup, cpl.
83501	Air hose cpl. w. pressurized cup connection, for SATA Spray-Master
120816	Pressure release screw (packing unit 2 pieces)
133983	Air connection piece 1/4" male thread
* please also order 8268	

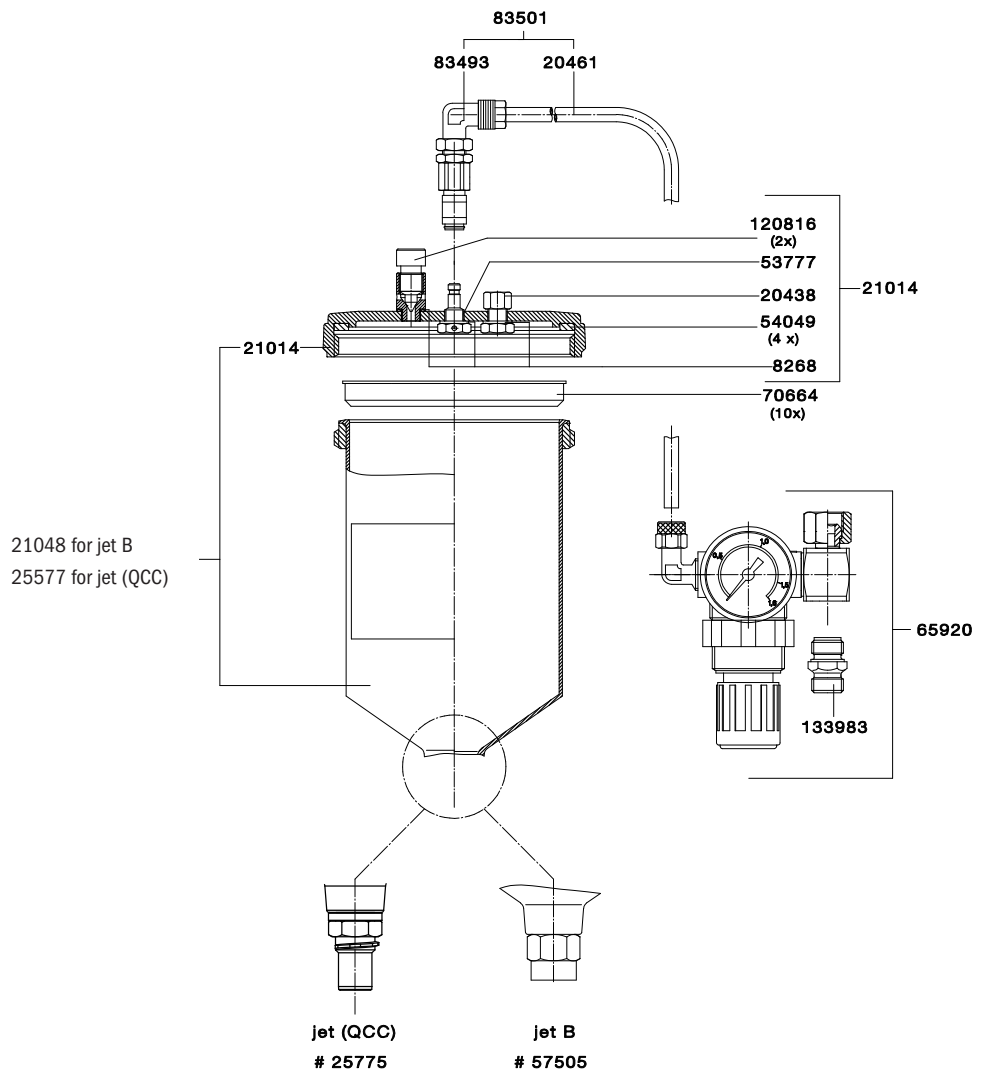

All prices are recommended list prices. Errors, technical modifications and printing errors reserved.